



Mel2™ Series

PROJECT NAME: _____

CATALOG: _____

NOTES: _____

LED High Bay



Key Features

- 150LPW
- DLC 4.3 Premium
- IP66
- 0-10V Dimming
- Narrow Beam | Wide Beam | High Rack
- 4000K & 5000K
- 110W | 150W | 210W
- UL/DLC
- 100-277V | 347-480V
- 70CRI
- 7 yr warranty

IP66



UP TO 150 SLPW

DESCRIPTION

The Mel2™ Series LED High Bay luminaire is a generation 3 product that meets the latest DLC 4.3 technical requirements, while being a best-in-class solution.. Built for indoor or outdoor harsh environments, this luminaire has an IP66 rating for water and dust exposure, a broad operating temperature and a solid die-cast aluminum housing. LED Driver is housed in own separate compartment therefore reducing thermal exposure and enabling longer life. Polyester powder coat finish enhances robustness and product meets ANSI B117 1000 hours salt fog test. Available in 3 wattages (110W, 145W & 210W) this product can replace up to 400-Watt metal halide fixtures in commercial, manufacturing, warehousing, food processing, marine, waste water treatment, car washes, and general wash down areas. Rebates available under High-bay lighting categories offered by participating utility companies.



CONSTRUCTION

Rugged die-cast aluminum housing & heat sink with optimized airflow design. Smooth round shape with electrostatic powder coat in multiple colors. Polyester powder coat for extreme environment exposure. Meets requirement ASTM B1117 1000 hours salt fog.

OPTICS

High Brightness LED arrays mounted on metal core circuit boards, with heat and impact resistant tempered clear glass or polycarbonate cover for protection. Light distribution patterns available in Narrow Beam, Wide Beam, both for open areas and High Rack for warehouse/Aisle lighting.

ELECTRICAL

Utilizes high-efficiency LEDs mounted to metal core circuit boards. 5000 Kelvin temperature standard, with additional color temperatures also available. High efficiency driver operates 100V through 277V, or 347-480V 50-60HZ. Integral surge protection standard and tested in accordance with IEEE/ANSI C62.41.2 to Category C. Dimming and other controls available.

INSTALLATION

Simple installation delivered by flexible mounting options such as Ceiling mount, chain mount, pendant mount and cable mount.

120-277V Input - 0-10V Dimming (Clear Cover)

Catalog Number	Model Number	Optics/ Other	Wattage (Watts)	Input Voltage (Volts)	Color Temp (Kelvin)	Optical (Degrees)	Beam Pattern	Lumens	LPW	Fixture		Fixture Exterior Color
										Lens	Dimming	
51091	MHB-40-100-UNV	HR-D-C	110	120-277	4000	60 x 100	Aisle	14080	128	Clear	Yes	White
51092	MHB-50-100-UNV	HR-D-C	110	120-277	5000	60 x 100	Aisle	14300	130	Clear	Yes	White
51093	MHB-40-100-UNV	WB-D-C	110	120-277	4000	125	Wide	16280	148	Clear	Yes	White
51094	MHB-50-100-UNV	WB-D-C	110	120-277	5000	125	Wide	16500	150	Clear	Yes	White
51095	MHB-40-100-UNV	NB-D-C	110	120-277	4000	60	Narrow	14080	128	Clear	Yes	White
51096	MHB-50-100-UNV	NB-D-C	110	120-277	5000	60	Narrow	14300	130	Clear	Yes	White
51591	MHB-40-150-UNV	HR-D-C	145	120-277	4000	60 x 100	Aisle	18560	128	Clear	Yes	White
51592	MHB-50-150-UNV	HR-D-C	145	120-277	5000	60 x 100	Aisle	18850	130	Clear	Yes	White
51593	MHB-40-150-UNV	WB-D-C	145	120-277	4000	125	Wide	21460	148	Clear	Yes	White
51594	MHB-50-150-UNV	WB-D-C	145	120-277	5000	125	Wide	21750	150	Clear	Yes	White
51595	MHB-40-150-UNV	NB-D-C	145	120-277	4000	60	Narrow	18560	128	Clear	Yes	White
51596	MHB-50-150-UNV	NB-D-C	145	120-277	5000	60	Narrow	18850	130	Clear	Yes	White
52091	MHB-40-200-UNV	HR-D-C	210	120-277	4000	60 x 100	Aisle	26880	128	Clear	Yes	White
52092	MHB-50-200-UNV	HR-D-C	210	120-277	5000	60 x 100	Aisle	27300	130	Clear	Yes	White
52093	MHB-40-200-UNV	WB-D-C	210	120-277	4000	125	Wide	31080	148	Clear	Yes	White
52094	MHB-50-200-UNV	WB-D-C	210	120-277	5000	125	Wide	31500	150	Clear	Yes	White
52095	MHB-40-200-UNV	NB-D-C	210	120-277	4000	60	Narrow	26880	128	Clear	Yes	White
52096	MHB-50-200-UNV	NB-D-C	210	120-277	5000	60	Narrow	27300	130	Clear	Yes	White

Each Model: PF ↑.95 THD ↓10% Operating Temp -25°C to 55°C

347-480V Input - 0-10V Dimming (Clear Cover)

Catalog Number	Model Number	Optics/ Other	Wattage (Watts)	Input Voltage (Volts)	Color Temp (Kelvin)	Optical (Degrees)	Beam Pattern	Lumens	LPW	Fixture		Fixture Exterior Color
										Lens	Dimming	
55091	MHB-40-100-347/480	HR-D-C	110	347-480	4000	60 x 100	Aisle	14080	128	Clear	Yes	White
55092	MHB-50-100-347/480	HR-D-C	110	347-480	5000	60 x 100	Aisle	14300	130	Clear	Yes	White
55093	MHB-40-100-347/480	WB-D-C	110	347-480	4000	125	Wide	16280	148	Clear	Yes	White
55094	MHB-50-100-347/480	WB-D-C	110	347-480	5000	125	Wide	16500	150	Clear	Yes	White
55095	MHB-40-100-N347/480	NB-D-C	110	347-480	4000	60	Narrow	14080	128	Clear	Yes	White
55096	MHB-50-100-347/480	NB-D-C	110	347-480	5000	60	Narrow	14300	130	Clear	Yes	White
56591	MHB-40-150-347/480	HR-D-C	145	347-480	4000	60 x 100	Aisle	18560	128	Clear	Yes	White
56592	MHB-50-150-347/480	HR-D-C	145	347-480	5000	60 x 100	Aisle	18850	130	Clear	Yes	White
56593	MHB-40-150-347/480	WB-D-C	145	347-480	4000	125	Wide	21460	148	Clear	Yes	White
56594	MHB-50-150-347/480	WB-D-C	145	347-480	5000	125	Wide	21750	150	Clear	Yes	White
56595	MHB-40-150-347/480	NB-D-C	145	347-480	4000	60	Narrow	18560	128	Clear	Yes	White
56596	MHB-50-150-347/480	NB-D-C	145	347-480	5000	60	Narrow	18850	130	Clear	Yes	White
57091	MHB-40-200-347/480	HR-D-C	210	347-480	4000	60 x 100	Aisle	26880	128	Clear	Yes	White
57092	MHB-50-200-347/480	HR-D-C	210	347-480	5000	60 x 100	Aisle	27300	130	Clear	Yes	White
57093	MHB-40-200-347/480	WB-D-C	210	347-480	4000	125	Wide	31080	148	Clear	Yes	White
57094	MHB-50-200-347/480	WB-D-C	210	347-480	5000	125	Wide	31500	150	Clear	Yes	White
57095	MHB-40-200-347/480	NB-D-C	210	347-480	4000	60	Narrow	26880	128	Clear	Yes	White
57096	MHB-50-200-347/480	NB-D-C	210	347-480	5000	60	Narrow	27300	130	Clear	Yes	White

Each Model: PF ↑.95 THD ↓10% Operating Temp -25°C to 55°C



Our unique array is optimized for best-in-class lumen output and efficacy at high drive currents. Superior engineering and design deliver the best performance in the industry.



120-277V Input - 0-10V Dimming (Frosted Cover)

Catalog Number	Model Number	Optics/ Other	Wattage (Watts)	Input Voltage (Volts)	Color Temp (Kelvin)	Optical (Degrees)	Beam Pattern	Lumens	LPW	Fixture Lens	Dimming	Fixture Exterior Color
61091	MHB-40-100-UNV	HR-D-F	110	120-277	4000	60 x 100	Aisle	13090	119	Frosted	Yes	White
61092	MHB-50-100-UNV	HR-D-F	110	120-277	5000	60 x 100	Aisle	13310	121	Frosted	Yes	White
61093	MHB-40-100-UNV	WB-D-F	110	120-277	4000	125	Wide	15180	138	Frosted	Yes	White
61094	MHB-50-100-UNV	WB-D-F	110	120-277	5000	125	Wide	15400	140	Frosted	Yes	White
61095	MHB-40-100-UNV	NB-D-F	110	120-277	4000	60	Narrow	13090	119	Frosted	Yes	White
61096	MHB-50-100-UNV	NB-D-F	110	120-277	5000	60	Narrow	13310	121	Frosted	Yes	White
61591	MHB-40-150-UNV	HR-D-F	145	120-277	4000	60 x 100	Aisle	17255	119	Frosted	Yes	White
61592	MHB-50-150-UNV	HR-D-F	145	120-277	5000	60 x 100	Aisle	17545	121	Frosted	Yes	White
61593	MHB-40-150-UNV	WB-D-F	145	120-277	4000	125	Wide	20010	138	Frosted	Yes	White
61594	MHB-50-150-UNV	WB-D-F	145	120-277	5000	125	Wide	20300	140	Frosted	Yes	White
61595	MHB-40-150-UNV	NB-D-F	145	120-277	4000	60	Narrow	17255	119	Frosted	Yes	White
61596	MHB-50-150-UNV	NB-D-F	145	120-277	5000	60	Narrow	17545	121	Frosted	Yes	White
62091	MHB-40-200-UNV	HR-D-F	210	120-277	4000	60 x 100	Aisle	24990	119	Frosted	Yes	White
62092	MHB-50-200-UNV	HR-D-F	210	120-277	5000	60 x 100	Aisle	25410	121	Frosted	Yes	White
62093	MHB-40-200-UNV	WB-D-F	210	120-277	4000	125	Wide	28980	138	Frosted	Yes	White
62094	MHB-50-200-UNV	WB-D-F	210	120-277	5000	125	Wide	29400	140	Frosted	Yes	White
62095	MHB-40-200-UNV	NB-D-F	210	120-277	4000	60	Narrow	24990	119	Frosted	Yes	White
62096	MHB-50-200-UNV	NB-D-F	210	120-277	5000	60	Narrow	25410	121	Frosted	Yes	White

Each Model: PF ↑.95 THD ↓10% Operating Temp -25°C to 55°C

347-480V Input - 0-10V Dimming (Frosted Cover)

Catalog Number	Model Number	Optics/ Other	Wattage (Watts)	Input Voltage (Volts)	Color Temp (Kelvin)	Optical (Degrees)	Beam Pattern	Lumens	LPW	Fixture Lens	Dimming	Fixture Exterior Color
65091	MHB-40-100-347/480	HR-D-F	110	347-480	4000	60 x 100	Aisle	13090	119	Frosted	Yes	White
65092	MHB-50-100-347/480	HR-D-F	110	347-480	5000	60 x 100	Aisle	13310	121	Frosted	Yes	White
65093	MHB-40-100-347/480	WB-D-F	110	347-480	4000	125	Wide	15180	138	Frosted	Yes	White
65094	MHB-50-100-347/480	WB-D-F	110	347-480	5000	125	Wide	15400	140	Frosted	Yes	White
65095	MHB-40-100-347/480	NB-D-F	110	347-480	4000	60	Narrow	13090	119	Frosted	Yes	White
65096	MHB-50-100-347/480	NB-D-F	110	347-480	5000	60	Narrow	13310	121	Frosted	Yes	White
66591	MHB-40-150-347/480	HR-D-F	145	347-480	4000	60 x 100	Aisle	17255	119	Frosted	Yes	White
66592	MHB-50-150-347/480	HR-D-F	145	347-480	5000	60 x 100	Aisle	17545	121	Frosted	Yes	White
66593	MHB-40-150-347/480	WB-D-F	145	347-480	4000	125	Wide	20010	138	Frosted	Yes	White
66594	MHB-50-150-347/480	WB-D-F	145	347-480	5000	125	Wide	20300	140	Frosted	Yes	White
66595	MHB-40-150-347/480	NB-D-F	145	347-480	4000	60	Narrow	17255	119	Frosted	Yes	White
66596	MHB-50-150-347/480	NB-D-F	145	347-480	5000	60	Narrow	17545	121	Frosted	Yes	White
67091	MHB-40-200-347/480	HR-D-F	210	347-480	4000	60 x 100	Aisle	24990	119	Frosted	Yes	White
67092	MHB-50-200-347/480	HR-D-F	210	347-480	5000	60 x 100	Aisle	25410	121	Frosted	Yes	White
67093	MHB-40-200-347/480	WB-D-F	210	347-480	4000	125	Wide	28980	138	Frosted	Yes	White
67094	MHB-50-200-347/480	WB-D-F	210	347-480	5000	125	Wide	29400	140	Frosted	Yes	White
67095	MHB-40-200-347/480	NB-D-F	210	347-480	4000	60	Narrow	24990	119	Frosted	Yes	White
67096	MHB-50-200-347/480	NB-D-F	210	347-480	5000	60	Narrow	25410	121	Frosted	Yes	White

Each Model: PF ↑.95 THD ↓10% Operating Temp -25°C to 55°C



Our UFO high-bay's external heat sink is lightweight and strong, allowing the fixture to run 35% cooler than competitive products, substantially increasing the lifespan and saving you money.



DIMENSIONS

110W

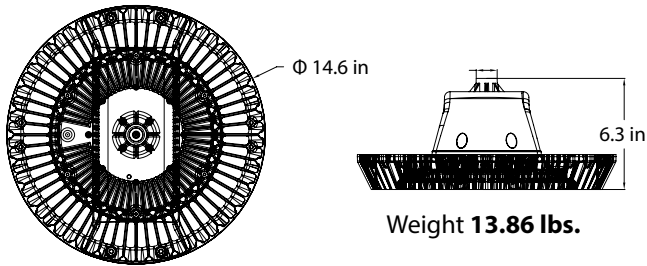

150W -210W

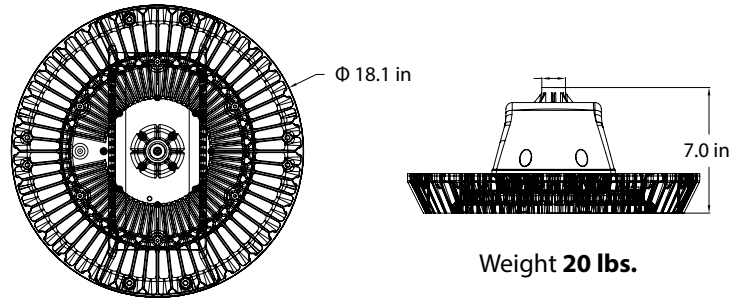

OPTICS

DISTRIBUTION CURVE FLUX

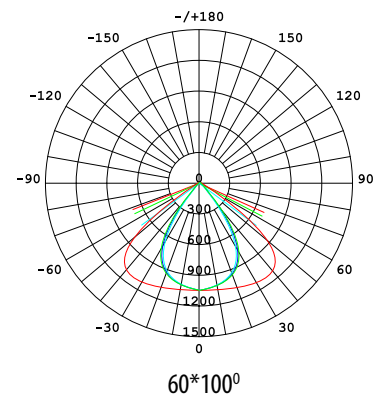
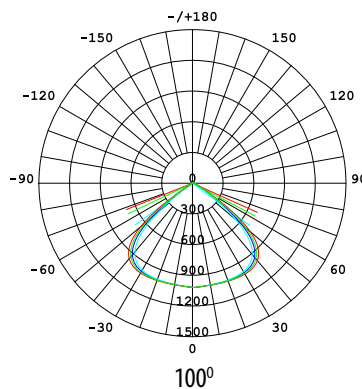
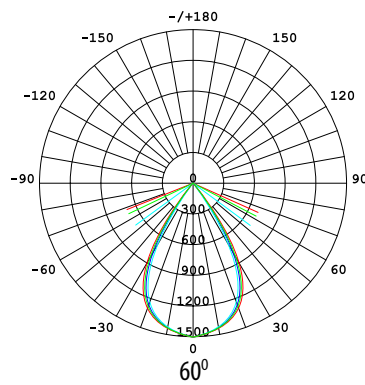

ACCESSORIES

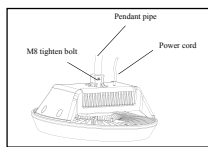

Catalog Number 50991
Model Number MHB-AA-PEN
Description Pendant Mount (3 foot Length)

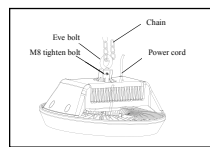

Catalog Number 50992
Model Number MHB-AA-CHA
Description Chain Mount (3 foot Length)

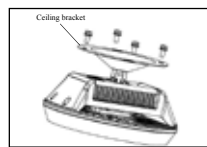

Catalog Number 50993
Model Number MHB-AA-CEI
Description Ceiling Mount



Catalog Number 50994
Model Number MHB-AA-PLU
Description Cord & Plug (6 foot length)



Catalog Number 50995
Model Number MHB-AA-BIR
Description Bird Guard



Catalog Number 50996
Model Number MHB-AA-WG-110
Description Wire Guard for 110W Fixture



Catalog Number 50997
Model Number MHB-AA-WG-210
Description Wire Guard for 145W or 210W Fixture



Catalog Number 50999
Model Number MHB-AA-BKT-110
Description Bracket for 110W Fixture



Catalog Number 51000
Model Number MHB-AA-BKT-210
Description Bracket for 145W and 210W Fixture

Please send orders to:
 Email: order@vm5lighting.com

We reserve the right to change our spec sheets at any time.

